

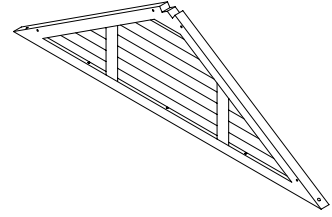

Lisa

A030.111.00

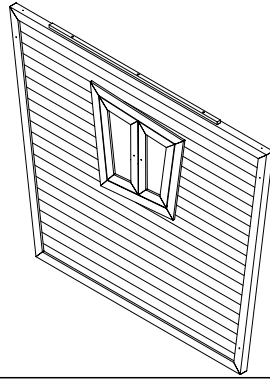
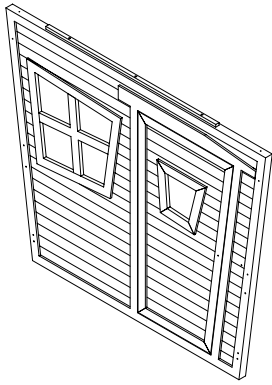

17

2x

12

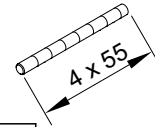

4 x 55

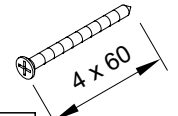

4 x 60

10

13



14x

t1

7x

s2

26x

A030.113.00

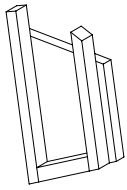

22

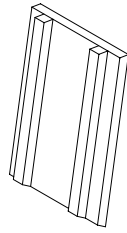

23

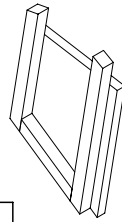

24

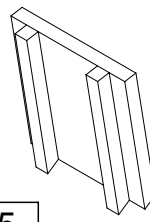

25

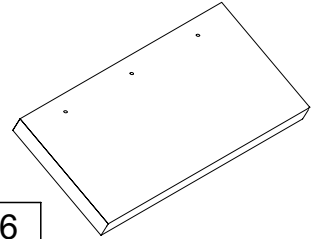

26

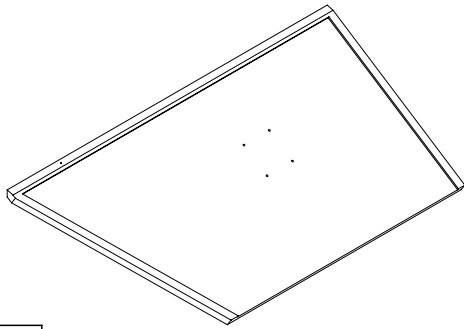

27

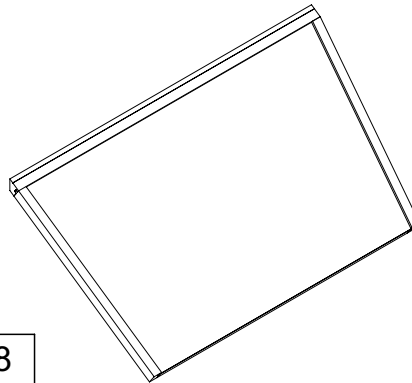

28

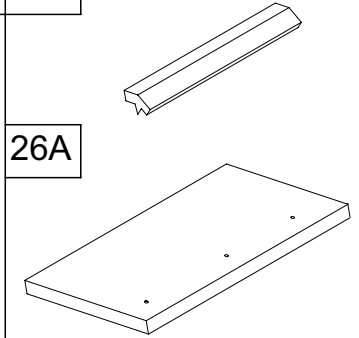

26A

26B

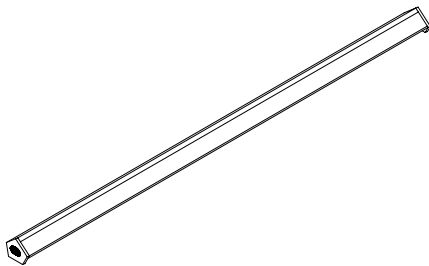

29

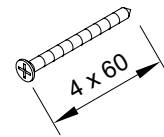

4 x 60

s2

8x

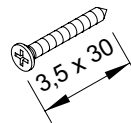

3,5 x 30

s3

16x

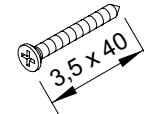

3,5 x 40

s4

15x



3 x 16

s6

6x

A030.117.00

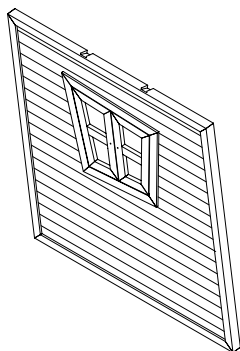

11

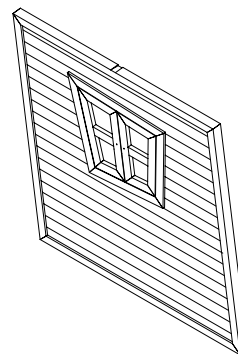

15



Lisa

A030.118.00

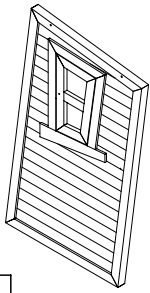

14

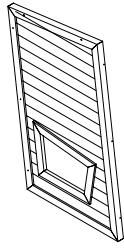

16

20

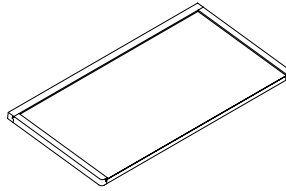

13



2x

21

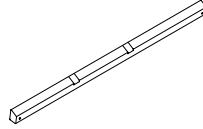

t1

1x

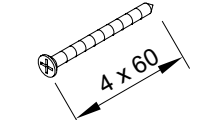
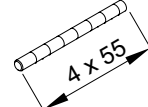

s2

14x

A030.119.00

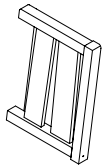

6

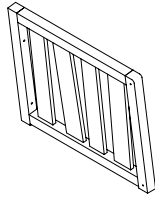

7

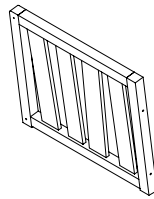

8

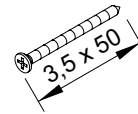

s1

12x

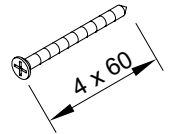

s2

12x

9

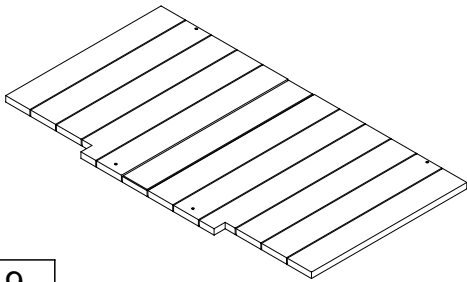

A030.120.00

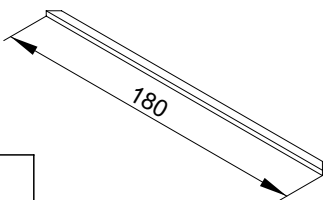

1

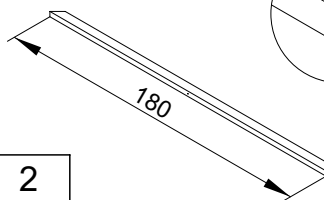

2

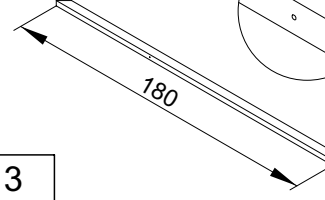

3

2x

4

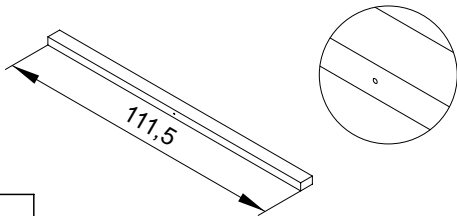

5

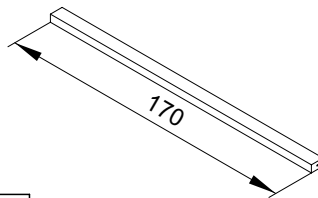

s1

8x

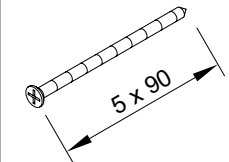

s5

4x

A030.142.00

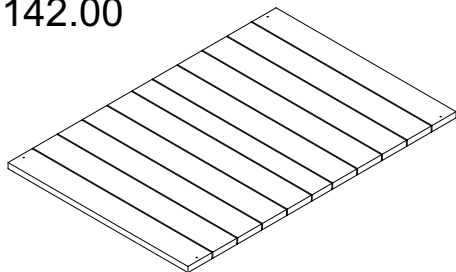

19

2x

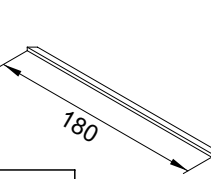
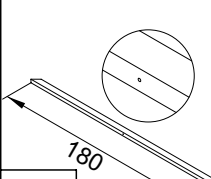
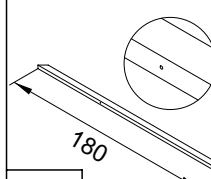
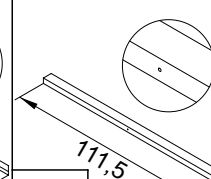
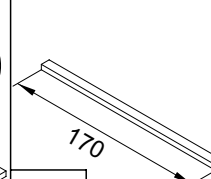
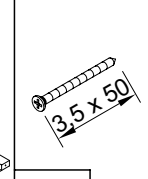
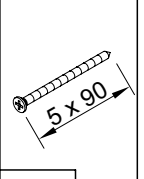
 1	 2	 3	 4	 5	 s1 8x	 s5 4x
--	--	--	--	---	--	--

A030.120.00

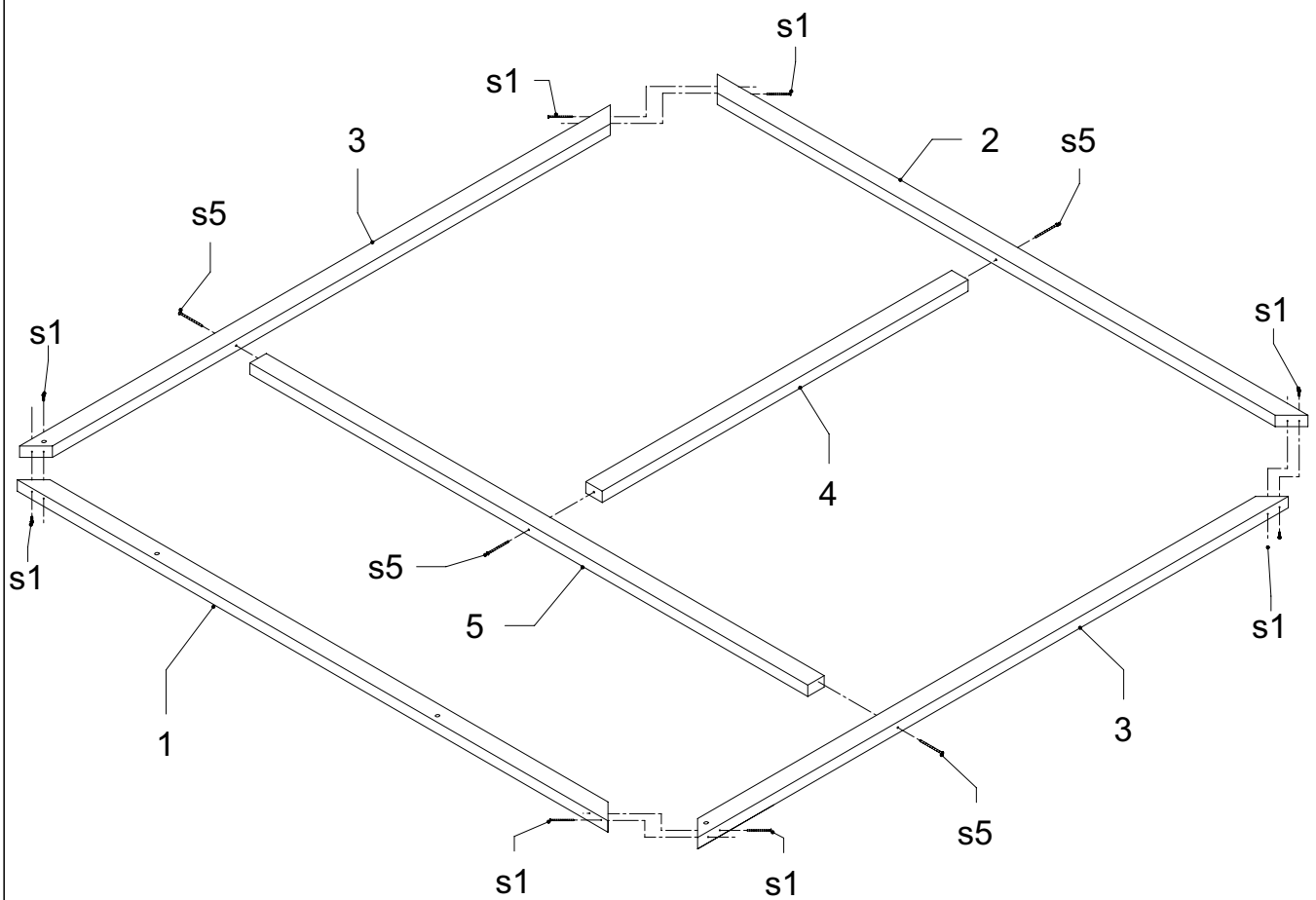



Lisa

6	2x	7	8	9	s1	4x	s2	8x

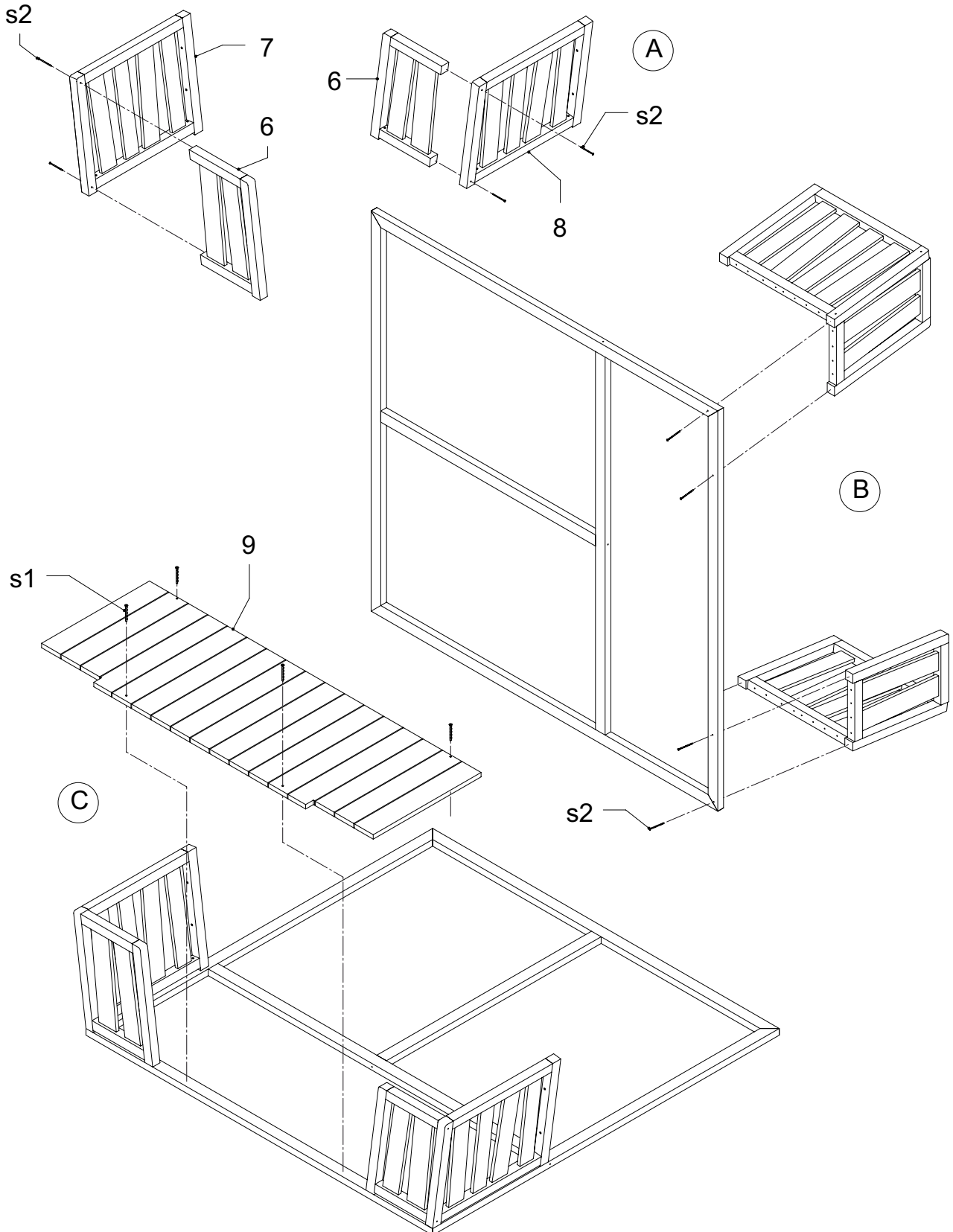

A030.119.00

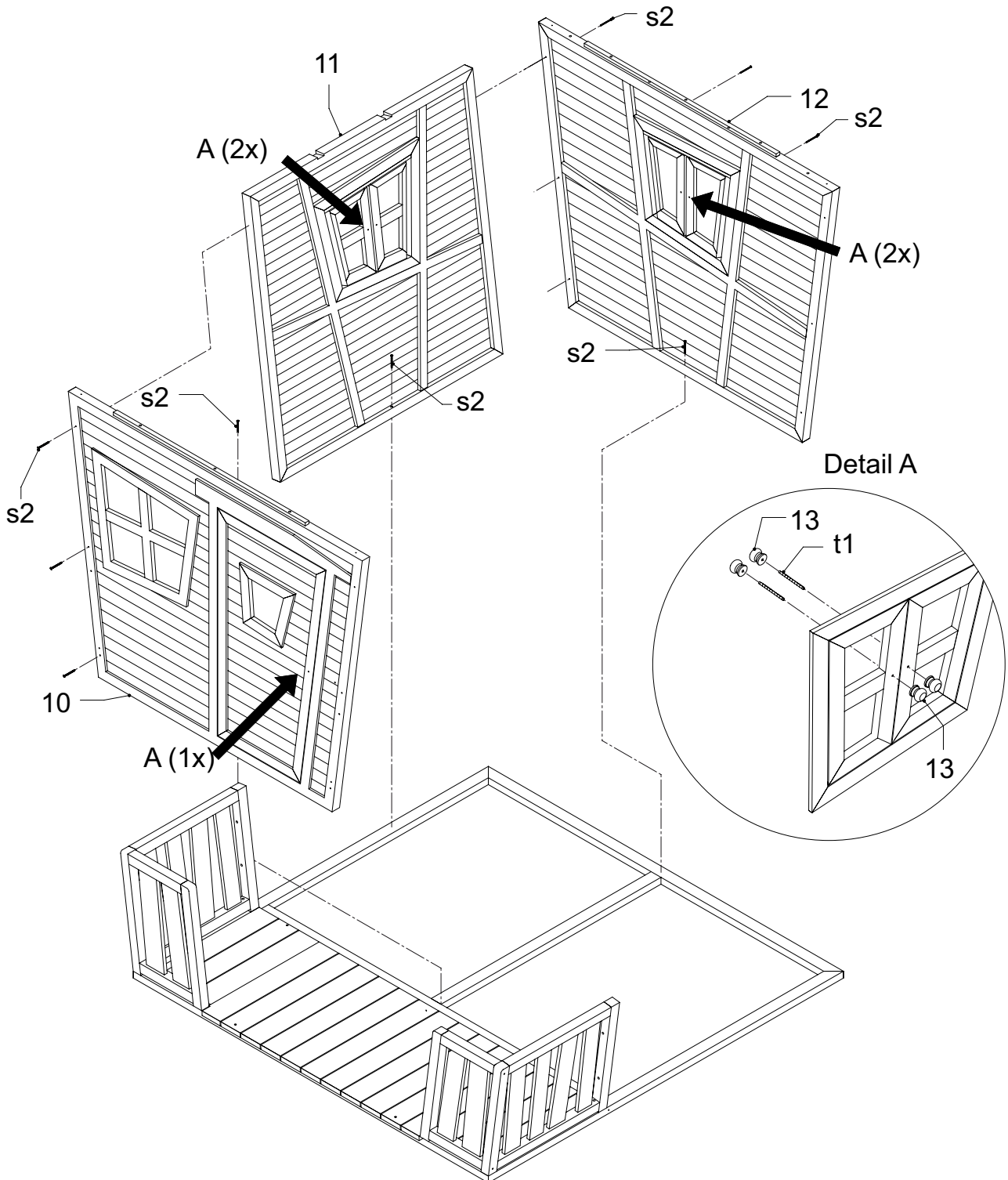

10	11	12	13	10x	t1	5x	s2	8x

A030.111.00 + A030.117.00

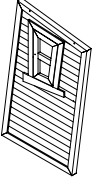
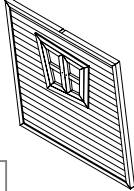
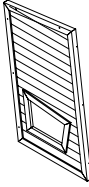

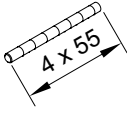
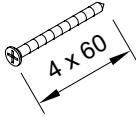
								
14	15	16	13	6x	t1	3x	s2	6x

A030.117.00 + A030.118.00

Detail A

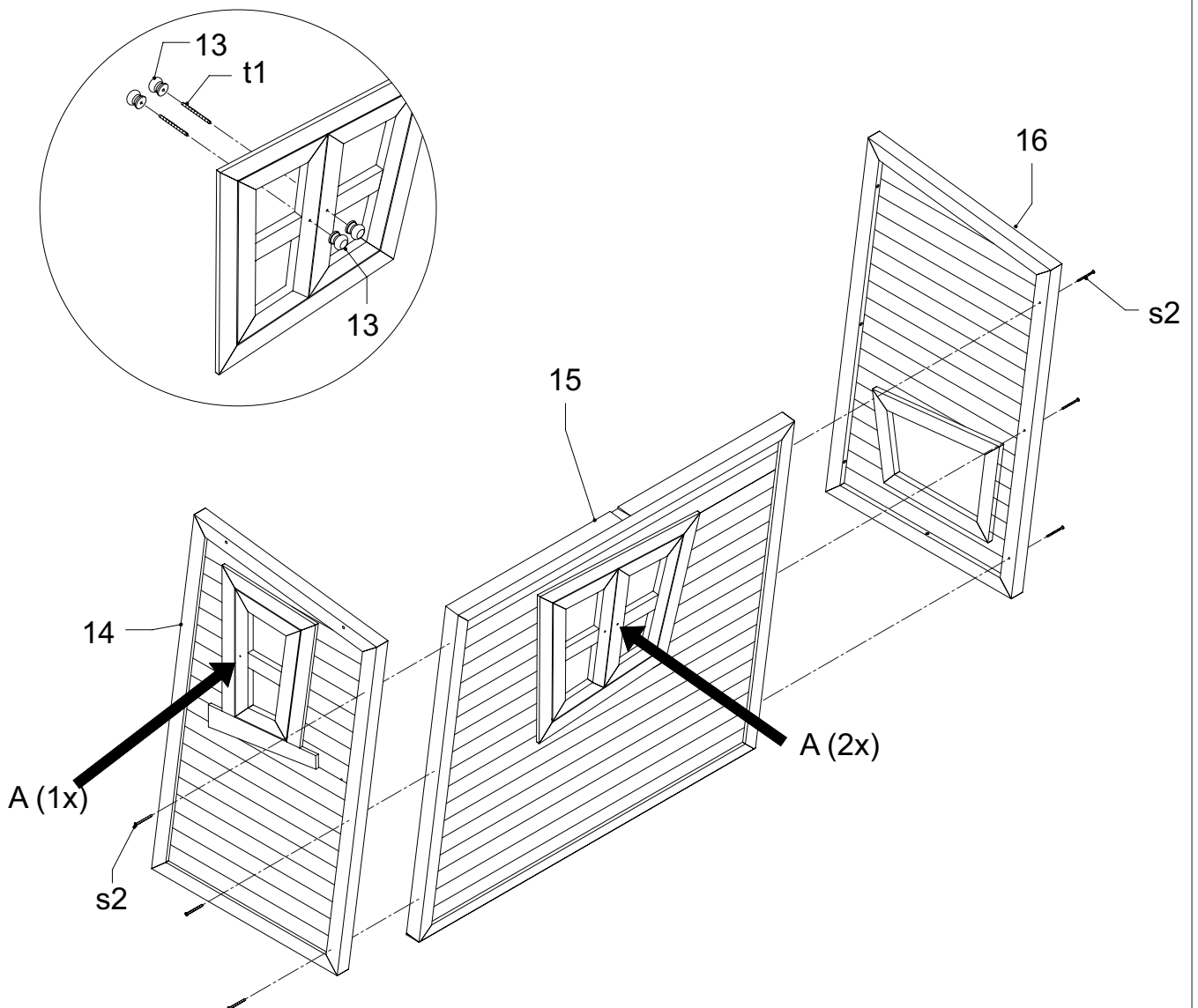

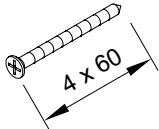

s2

9x

A030.111.00

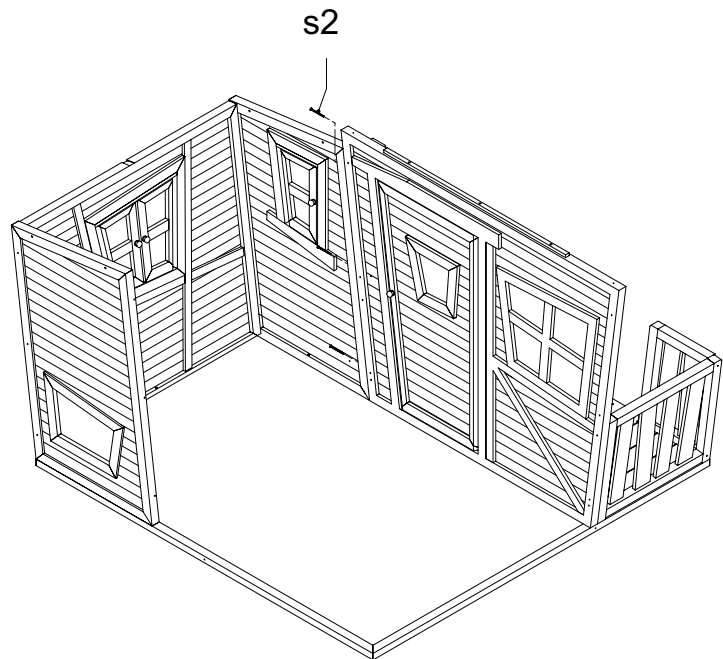
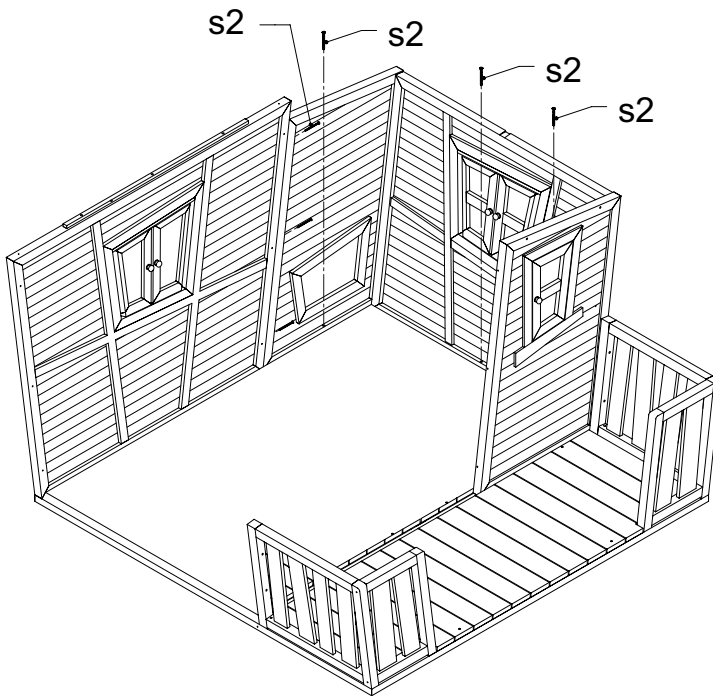

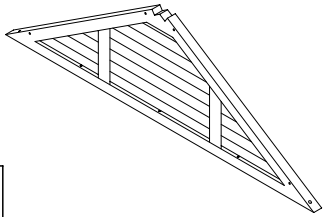

17

2x

s2

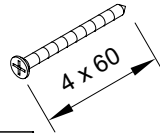

14x

A030.111.00 + A030.119.00

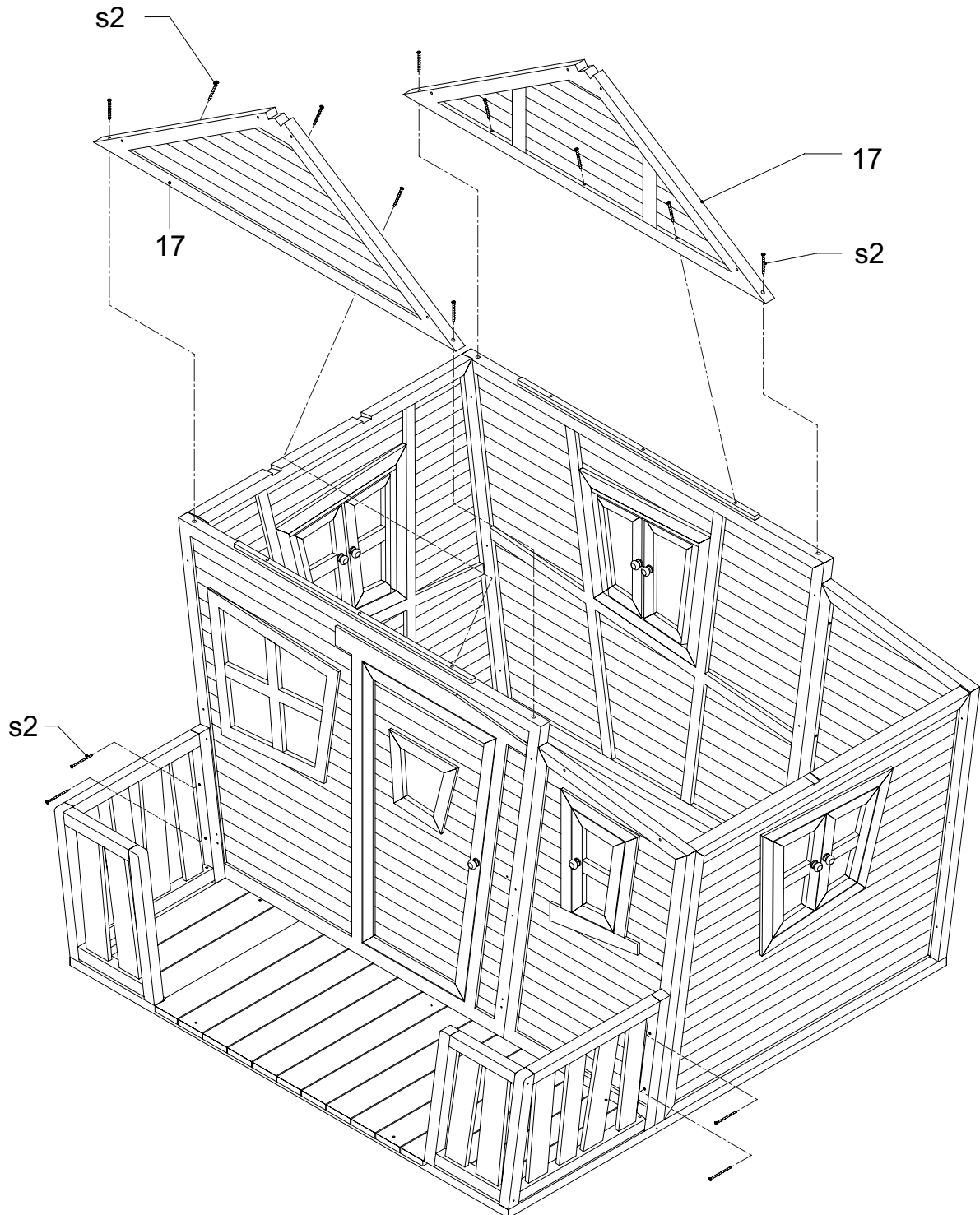

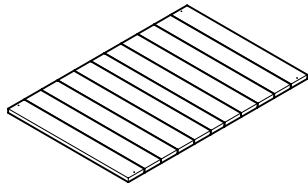

19

2x

s1

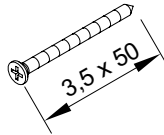

8x

A030.119.00 + A030.142.00

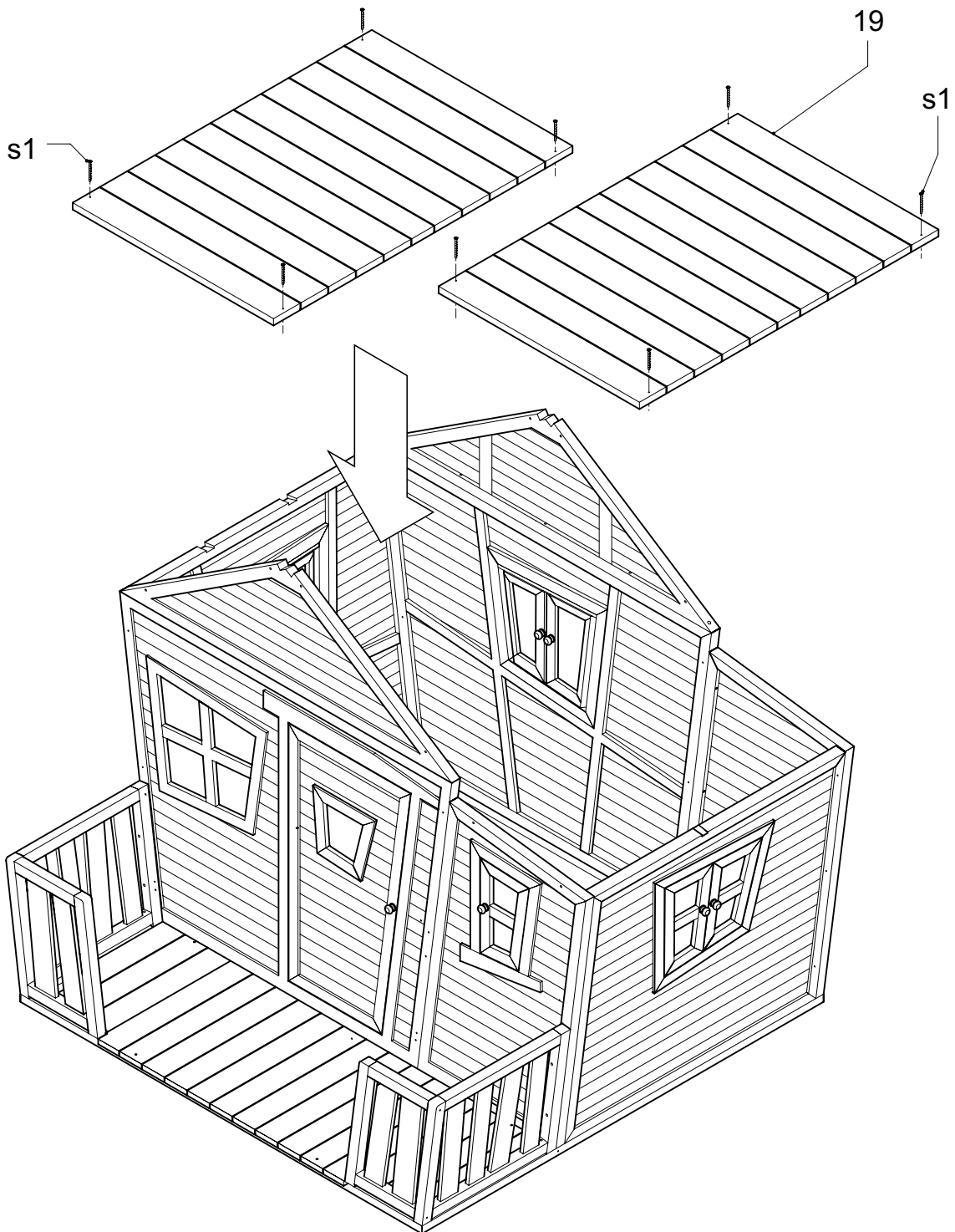

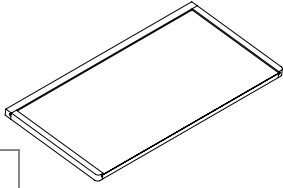
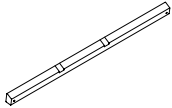
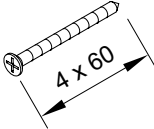
			6x
20	21	s2	

A030.118.00

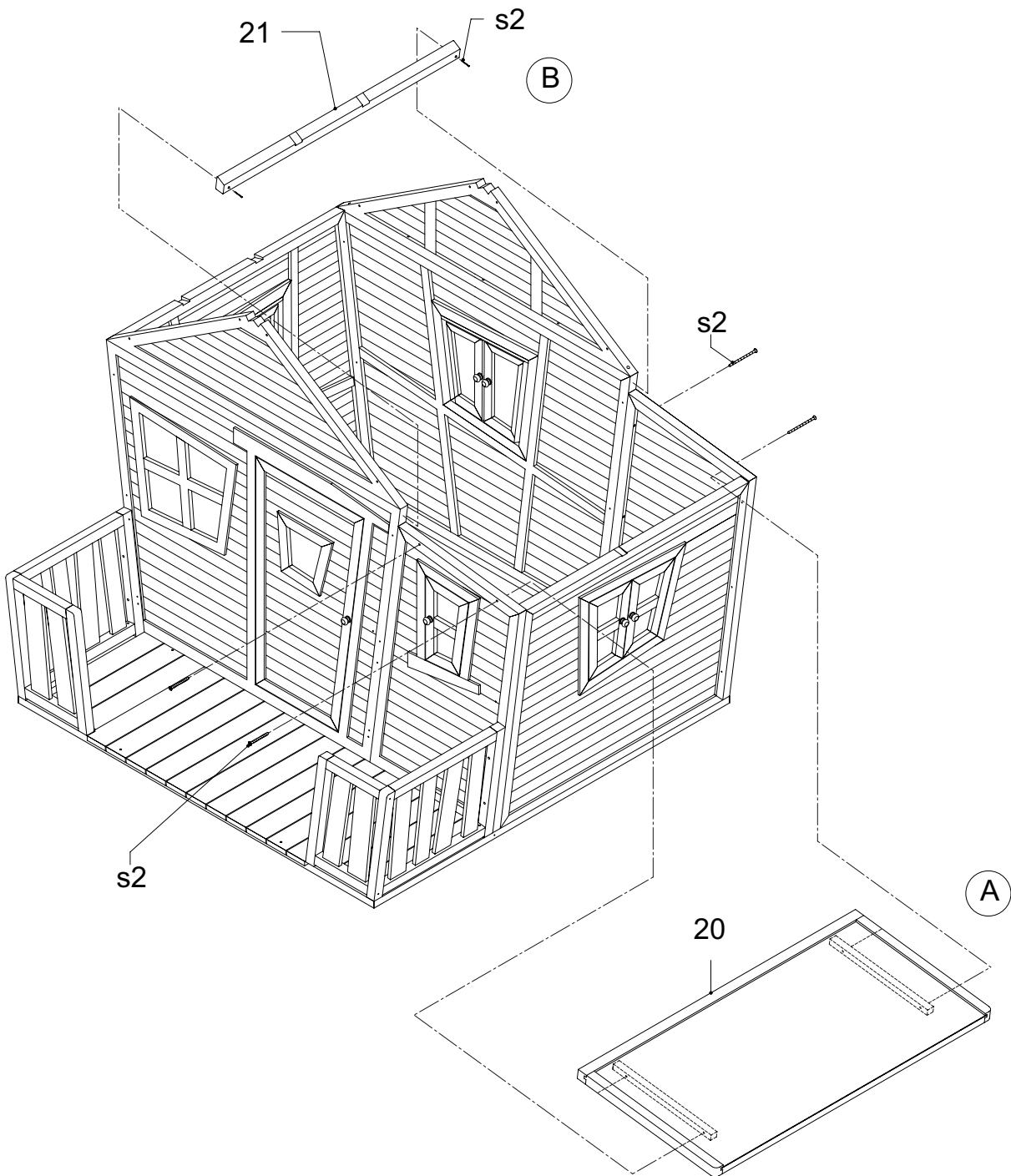



22	23	24	25	26	26A	26B	27	s3 16x	s6 6x

A030.113.00

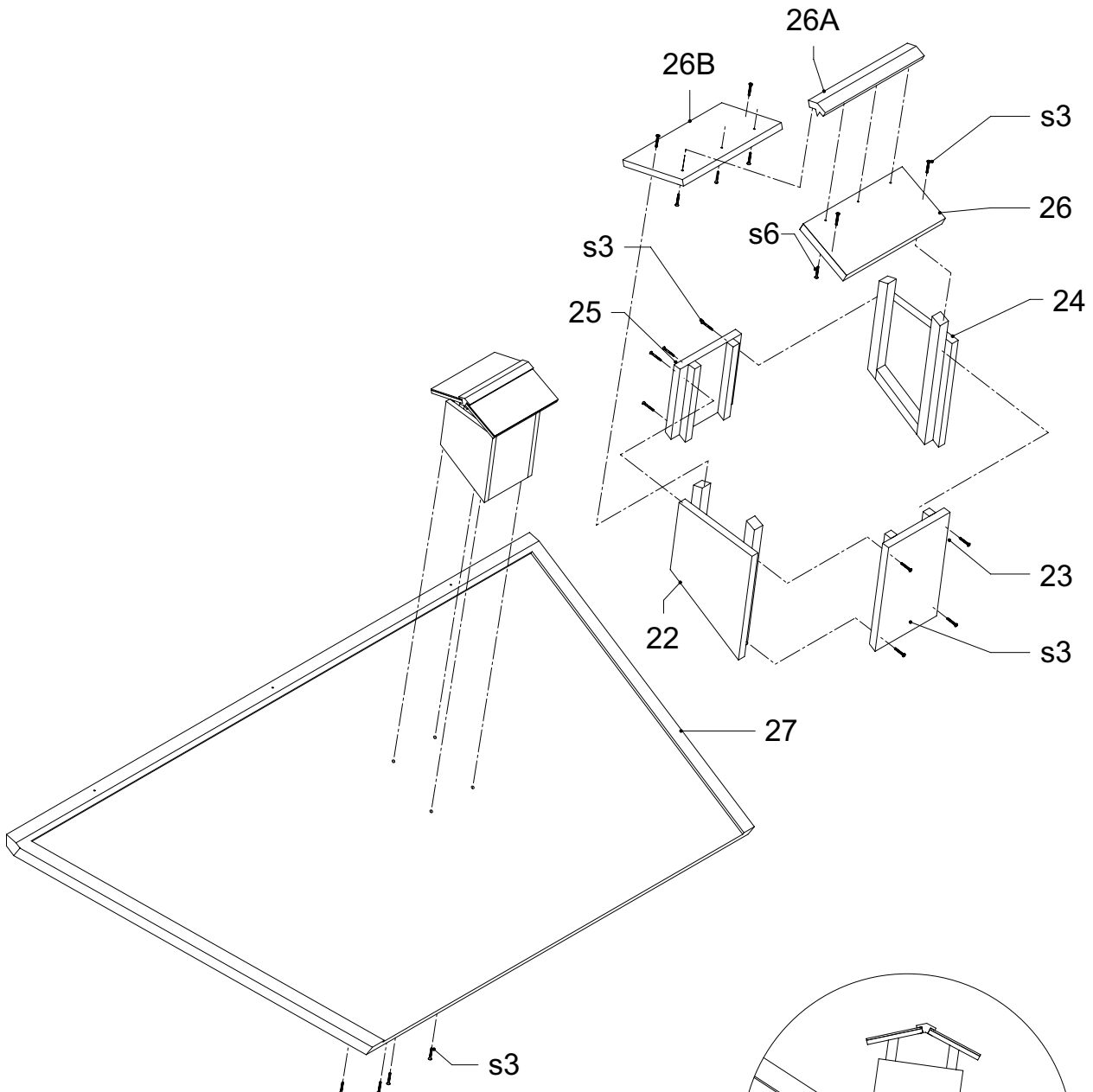

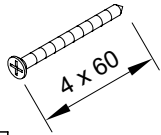

s2

4x

A030.113.00

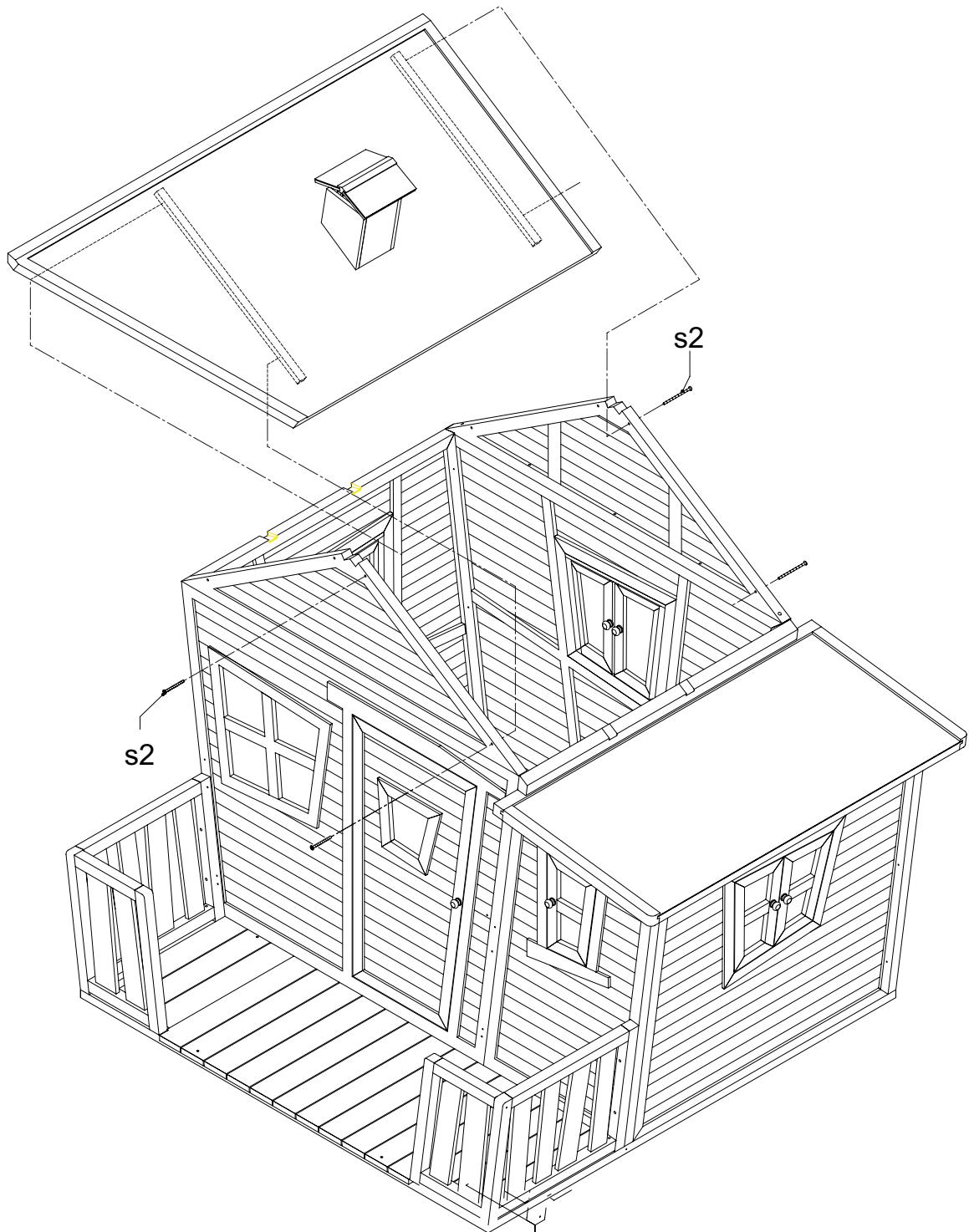

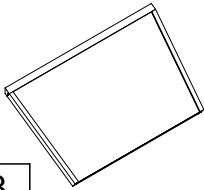

28

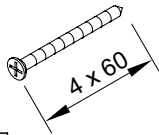

s2

4x

A030.113.00

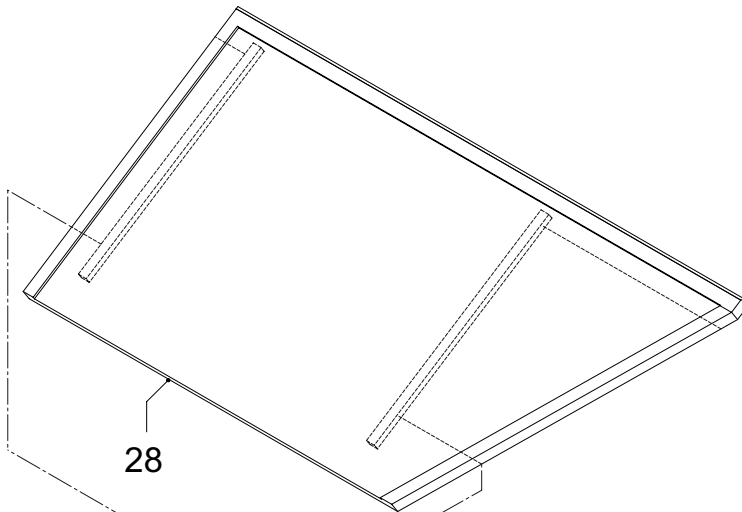

28

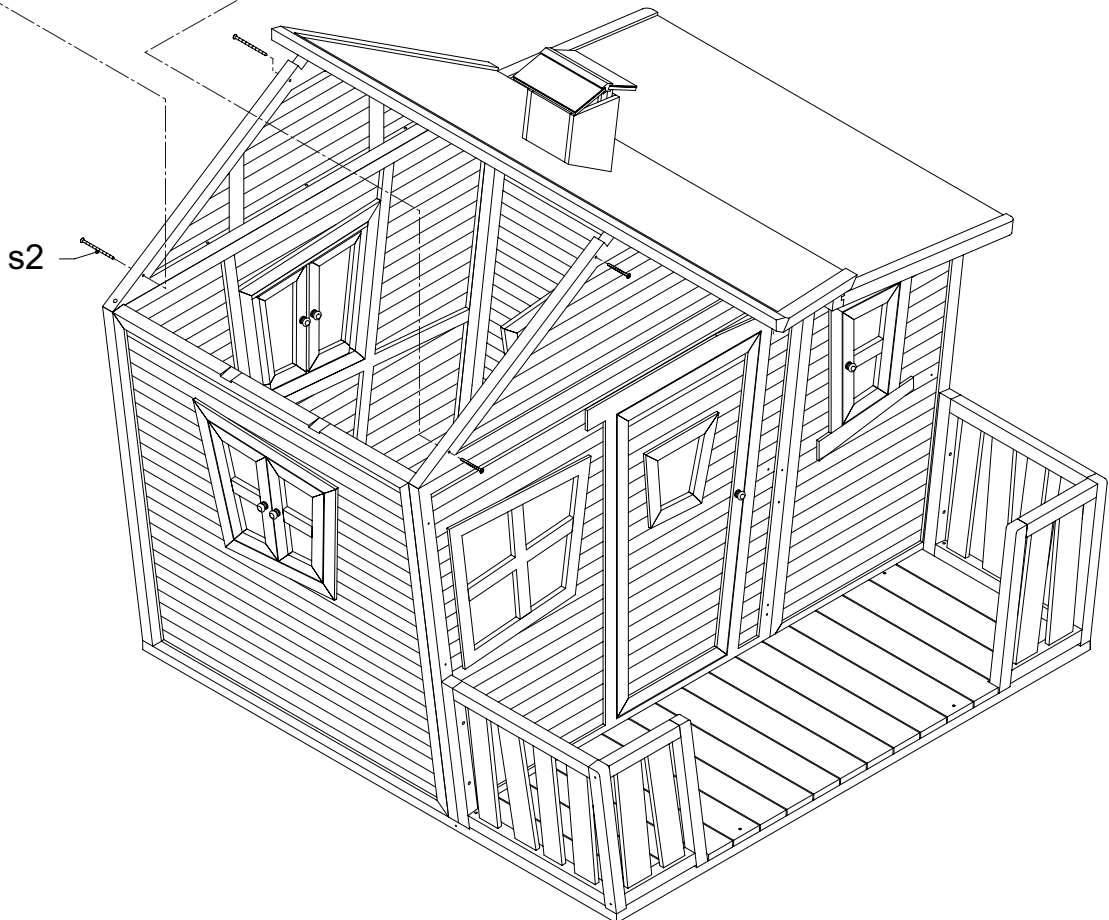

s2



29

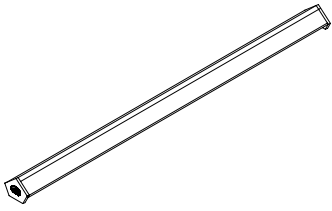

s4

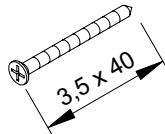

15x

A030.113.00

